

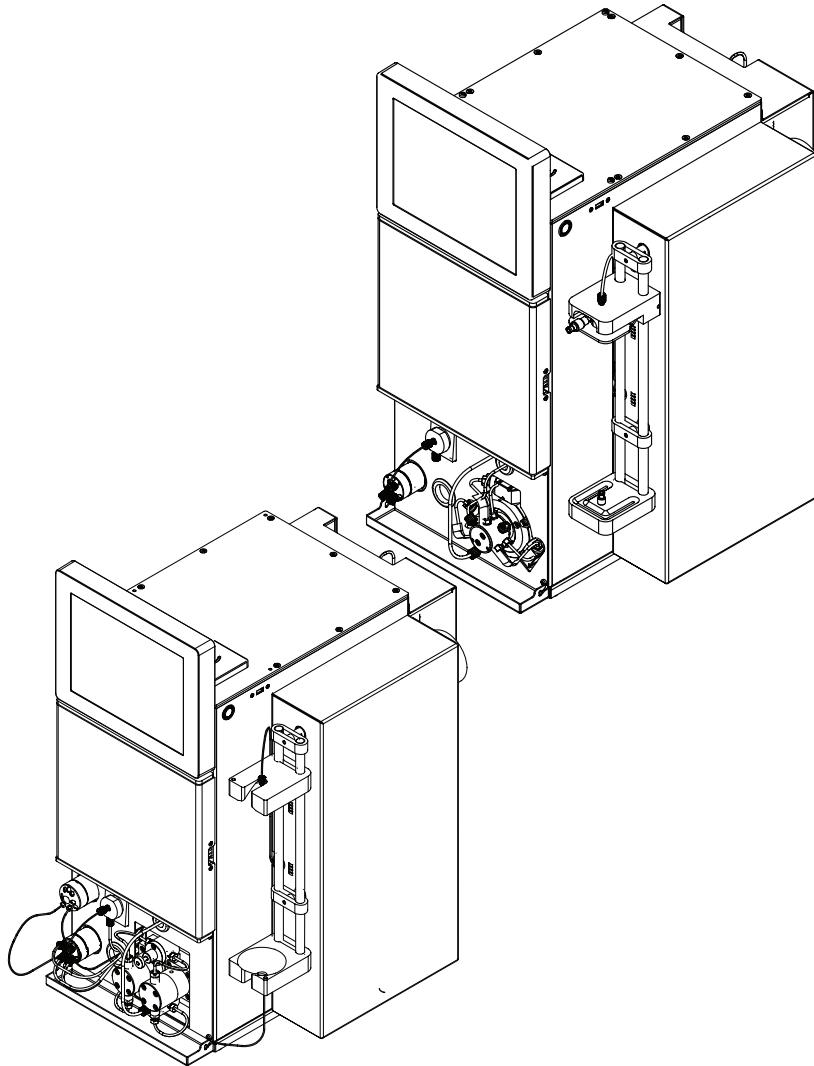

Pure Chromatography Instruments

Technical data sheet

The Pure chromatography instruments are extremely compact, ensure safety on the highest level and are easy to use for any application. With the platform it's possible to combine different techniques without sacrificing features or functionalities: Flash & prep HPLC and UV & ELS detection. This gives the chemist highest flexibility and helps to achieve the best purification results.



Алматы (7273)495-231
Ангарск (3955)60-70-56
Архангельск (8182)63-90-72
Астрахань (8512)99-46-04
Барнаул (3852)73-04-60
Белгород (4722)40-23-64
Благовещенск (4162)22-76-07
Брянск (4832)59-03-52
Владивосток (423)249-28-31
Владикавказ (8672)28-90-48
Владимир (4922)49-43-18
Волгоград (844)278-03-48
Вологда (8172)26-41-59
Воронеж (473)204-51-73
Екатеринбург (343)384-55-89

Иваново (4932)77-34-06
Ижевск (3412)26-03-58
Иркутск (395)279-98-46
Казань (843)206-01-48
Калининград (4012)72-03-81
Калуга (4842)92-23-67
Кемерово (3842)65-04-62
Киров (8332)68-02-04
Коломна (4966)23-41-49
Кострома (4942)77-07-48
Краснодар (861)203-40-90
Красноярск (391)204-63-61
Курск (4712)77-13-04
Курган (3522)50-90-47
Липецк (4742)52-20-81

Магнитогорск (3519)55-03-13
Москва (495)268-04-70
Мурманск (8152)59-64-93
Набережные Челны (8552)20-53-41
Нижний Новгород (831)429-08-12
Новокузнецк (3843)20-46-81
Ноябрьск (3496)41-32-12
Новосибирск (383)227-86-73
Омск (3812)21-46-40
Орел (4862)44-53-42
Оренбург (3532)37-68-04
Пенза (8412)22-31-16
Петрозаводск (8142)55-98-37
Псков (8112)59-10-37
Пермь (342)205-81-47

Ростов-на-Дону (863)308-18-15
Рязань (4912)46-61-64
Самара (846)206-03-16
Санкт-Петербург (812)309-46-40
Саратов (845)249-38-78
Севастополь (8692)22-31-93
Саранск (8342)22-96-24
Симферополь (3652)67-13-56
Смоленск (4812)29-41-54
Сочи (862)225-72-31
Ставрополь (8652)20-65-13
Сургут (3462)77-98-35
Сыктывкар (8212)25-95-17
Тамбов (4752)50-40-97
Тверь (4822)63-31-35

Тольятти (8482)63-91-07
Томск (3822)98-41-53
Тула (4872)33-79-87
Тюмень (3452)66-21-18
Ульяновск (8422)24-23-59
Улан-Удэ (3012)59-97-51
Уфа (347)229-48-12
Хабаровск (4212)92-98-04
Чебоксары (8352)28-53-07
Челябинск (351)202-03-61
Ставрополь (8202)49-02-64
Чита (3022)38-34-83
Якутск (4112)23-90-97
Ярославль (4852)69-52-93

Россия +7(495)268-04-70

Казахстан +7(7172)727-132

Киргизия +996(312)96-26-47

Scope of delivery

All configurations are supplied ready to use.

	Pure C-810	Pure C-815	Pure C-830	Pure C-835	Pure C-850
Pure C-810 Flash	1	-	-	-	-
Pure C-815 Flash	-	1	-	-	-
Pure C-830 Prep	-	-	1	-	-
Pure C-835 Prep	-	-	-	1	-
Pure C-850 FlashPrep	-	-	-	-	1
Power cord	1	1	1	1	1
Solvent line kit	1	1	1	1	1
Solvent bottle cap GL-45	5	5	5	5	5
Solvent cap UNF14	5	5	5	5	5
Operation manual	1	1	1	1	1
Tool kit flash	1	1	-	-	1
Tool kit prep	-	-	1	1	1
Pure cartridge holder	1	1	-	-	1
Pure column holder	-	-	1	1	1
Sample loop 5ml (5/16-24, OD1/8")	-	-	1	1	1
Cartridge bypass	1	1	-	-	1
Exhaust tubing ELSD	-	1	-	1	1
Pure air filter	1	1	1	1	1

Order code

Choose the configuration according to your needs:

1 1 C 8 **0 0**

Configuration

- 10 Pure C-810 Flash
- 15 Pure C-815 Flash
- 30 Pure C-830 Prep
- 35 Pure C-835 Prep
- 50 Pure C-850 FlashPrep

Technical data

Pure Chromatography Instruments

	Pure C-810	Pure C-815	Pure C-830	Pure C-835	Pure C-850
Dimension (W x D x H)	365 x 570 x 680 mm	365 x 570 x 680 mm	365 x 570 x 680 mm	365 x 570 x 680 mm	365 x 570 x 680 mm
Weight	25 kg	27 kg	31 kg	33 kg	33 kg
Power consumption	350 W	350 W	350 W	350 W	350 W
Connection voltage	100 - 240 V ± 10 %	100 - 240 V ± 10 %	100 - 240 V ± 10 %	100 - 240 V ± 10 %	100 - 240 V ± 10 %
Frequency	50 - 60 Hz	50 - 60 Hz	50 - 60 Hz	50 - 60 Hz	50 - 60 Hz
Fuse	4 A	4 A	4 A	4 A	4 A
Overvoltage category	II	II	II	II	II
IP Code	IP 20	IP 20	IP 20	IP 20	IP 20
Solvents	4	4	4	4	4
Gas pressure (maximum)	8 bar	8 bar	8 bar	8 bar	8 bar
Compressed air	oil and dust free	oil and dust free	oil and dust free	oil and dust free	oil and dust free
USB port	3	3	3	3	3
LAN port (RJ45)	1	1	1	1	1
RFID reader (racks)	Yes	Yes	Yes	Yes	Yes
RFID reader (cartridges)	Yes	Yes	No	No	Yes
Fraction collector bay	closed	closed	closed	closed	closed
Lighted fraction collector bay	Yes	Yes	Yes	Yes	Yes
Solvent level sensor	Yes	Yes	Yes	Yes	Yes
Waste level sensor	Yes	Yes	Yes	Yes	Yes
Vapor sensor	Yes	Yes	Yes	Yes	Yes

Pump Flash Mode

	Pure C-810	Pure C-815	Pure C-830	Pure C-835	Pure C-850
Gradient	binary	binary	-	-	binary
Pressure range	0 - 50 bar	0 - 50 bar	-	-	0 - 50 bar
Flow rate	0 - 250 mL/ min	0 - 250 mL/ min	-	-	0 - 250 mL/ min
Flow rate accuracy	< 2 %	< 2 %	-	-	< 2 %
Functional principle	self-priming	self-priming	-	-	self-priming

	Pure C-810	Pure C-815	Pure C-830	Pure C-835	Pure C-850
Specification	3 pistons radial ar- ranged	3 pistons radial ar- ranged	-	-	2 pistons parallel ar- ranged

Pump Prep Mode

	Pure C-810	Pure C-815	Pure C-830	Pure C-835	Pure C-850
Gradient	-	-	binary	binary	binary
Pressure range	-	-	0-300 bar	0-300 bar	0-300 bar
Flow rate	-	-	0 - 100 ml/min	0 - 100 ml/min	0 - 100 ml/min
Flow rate accuracy	-	-	< 2 %	< 2 %	< 2 %
Functional principle	-	-	self-priming	self-priming	self-priming
Specification	-	-	2 pistons parallel ar- ranged	2 pistons parallel ar- ranged	2 pistons parallel ar- ranged

UV Detector

	Pure C-810	Pure C-815	Pure C-830	Pure C-835	Pure C-850
UV - Vis wavelength range	200 - 800 nm	200 - 800 nm	200 - 800 nm	200 - 800 nm	200 - 800 nm
Light sources	Halogen / Deuterium	Halogen / Deuterium	Halogen / Deuterium	Halogen / Deuterium	Halogen / Deuterium
Lifetime lamp	2000 hours	2000 hours	2000 hours	2000 hours	2000 hours
Detector	DAD	DAD	DAD	DAD	DAD
DAD scan	entire range	entire range	entire range	entire range	entire range

ELSD Detector

	Pure C-810	Pure C-815	Pure C-830	Pure C-835	Pure C-850
Light output laser	-	0.3 mW	-	1 mW	1 mW
Pressure carrier air	-	~0.8 bar	-	~0.8 bar	~0.8 bar
Pressure spray air	-	3 - 3.5 bar	-	3 - 3.5 bar	3 - 3.5 bar
Flow rate air	-	2 - 2.5 L/min	-	2 - 2.5 L/min	2 - 2.5 L/min

Ambient conditions



For indoor use only.

Max. altitude above sea level	2000 m
Ambient temperature	5–40°C (25°C) No maximum performance above 25°C
Maximum relative humidity	80% non-condensing, for temperatures up to 31°C
Storage temperature	max. 45 °C

Spare parts and accessories

Accessories

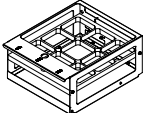
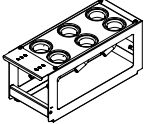
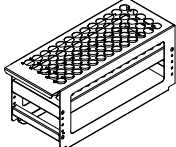
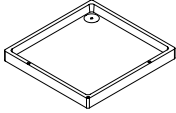
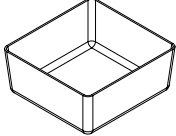
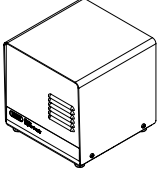
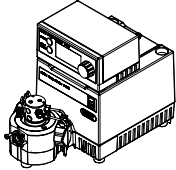
	Order no.	Image
Pure rack type 1 Rack for 12 x 75 mm glass tubes, 1 pc.	11066672	
Pure rack type 2 Rack for 13 x 100 mm glass tubes, 1 pc.	11066673	
Pure rack type 3 Rack for 16 x 125 mm glass tubes, 1 pc.	11066674	
Pure rack type 4 Rack for 16 x 150 mm glass tubes, 1 pc.	11066675	
Pure rack type 5 Rack for 18 x 150 mm glass tubes, 1 pc.	11066676	
Pure rack type 6 Rack for 25 x 150 mm glass tubes, 1 pc.	11066677	

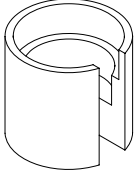
	Order no.	Image
Pure rack type 7 Rack for 9 squared bottles of 480 mL, 1 pc.	11068452	
Pure rack type 8 (funnel rack) Rack for 6 funnels	11069407	
Pure rack type 9 Rack for 16 x 100 mm glass tubes, 1 pc.	11069242	
Solvent bottle platform kit Solvent bottle platform on top of the instrument. For maximum 4 bottles (volume 4 L each)	11069285	
Retaining container Retaining container for solvent bottle platform for more safety regarding leaking	11068468	
Pure Dry Air Supply unit	11069026	
Loading Pump with flow rates from 2.5 to 250 mL/min, incl. tubing and fitting	11071418	
Pure cartridge holder XXL Cartridge holder for cartridges of 800 g to 5000 g	11070532	
Pure column holder XL Column holder for column diameters 50 to 70 mm	11068467	

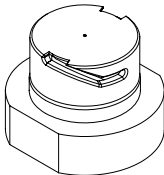
	Order no.	Image
Pure nebulizer set	11069464	

Tubes

	Order no.
Pure Glass Tubes 13 x 100 mm 1000 pcs.	148623414
Pure Glass Tubes 16 x 150 mm 1000 pcs.	148623416
Pure Glass Tubes 18 x 150 mm 500 pcs.	148623410
Pure Glass Tubes 25 x 150 mm 500 pcs.	148623411
Pure Squared bottles 480 mL 24 pcs.	148623412



Tools and adapter kits

	Order no.
Luer lock connection set Set of 2 luer lock adapters	11068242
Advanced adapter kit flash Tube cutter, Fittings (1/8", 1/16"), Tubing (pneumatic, FEP 1/8", FEP 1/16"), Luer Lock adapters, Pneumatic reduction, Fuses, Injection valve	11068361
Advanced adapter kit prep Wrenches, Fittings (1/8", 1/16"), One piece fitting, 1/16", Tubing (pneumatic, FEP 1/8", PEEK 1/16"), SS nut and ferrule, Reductions, Fuses	11068362
Advanced adapter kit flash/prep Tube cutter, Wrenches, Fittings (1/8", 1/16"), One piece fitting, 1/16", Tubing (pneumatic, FEP 1/8", FEP PEEK 1/16"), SS nut and ferrule, Reductions, Luer Lock adapters, Fuses, Injection valve	11068363
Pure solvent line kit Package with 4 solvent lines and 5 level sensing lines	11068215
Kit Steel Tubing Prep units To replace the PEEK tubing with stainless steel tubing (for Prep instruments)	11070081

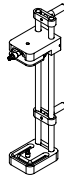
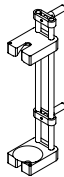
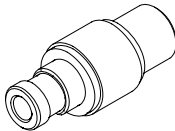

Sample introduction accessories

	Order no.
Pure Solid loader S set, incl. adapter set, sleeve, tubes (20 pcs.) and frits (40 pcs.)	11068975
Pure Solid loader M set, incl. adapter set, sleeve, tubes (20 pcs.) and frits (40 pcs.)	11070505
Pure Solid loader frits S (40 pcs.)	11068969
Pure Solid loader frits M (40 pcs.)	11069654
Pure Solid loader tubes S (20 pcs.)	11068971
Pure Solid loader tubes M (20 pcs.)	11069653
Pure Solid loader insertion rod S (1 pc.)	11068973
Pure Solid loader insertion rod M (1 pc.)	11070569
Male union 1/4"-28 sl	11070416
Pure sample loop 2 ml, 1 pc.	11068476
Pure sample loop 5 ml, 1 pc.	11068205
Pure sample loop 10 ml, 1 pc.	11068206

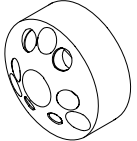
Spare parts

	Order no.	Image
Pure cartridge holder Cartridge holder for cartridges for 4 g to 330 g	11065940	
Pure column holder Column holder for columns diameters 10mm to 50mm	11066594	
Injection valve UNF 1/4"-28	044867	
Pure transfer line ELSD	11069409	
Touch-screen stylus	11068360	
Sample injection & mode valve stator	11069688	

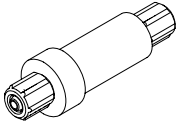
Wear parts

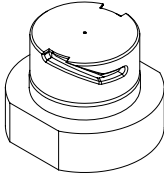
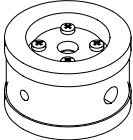
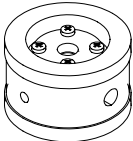
	Order no.	Image
Pure air filter	11066049	
O-Ring for Pure nebulizer	11066421	
Pure nebulizer	11066423	
Pure UV flow cell 0.3 mm For all C-8xx	11068210	
Pure UV flow cell 1.3 mm For all C-8xx, for enhanced sensitivity	11068214	
Shuttle valve rotor & head	11068229	
Hose SV-ELSD cpl.	11069457	
Pure Solid loader test 20 pcs	11069686	

IQ/OQ kits

	Order no.
IQ/OQ kits	11069235
C-810 / C-815 documentation IQ/OQ en	
IQ/OQ kits	11069236
C-830 / C-835 documentation IQ/OQ set en	
IQ/OQ kits	11069237
C-850 documentation IQ/OQ set en	
IQ/OQ kits	11069410
Repeating OQ C-810 / C-815 en	
IQ/OQ kits	11069412
Repeating OQ C-830 / C-835 en	
IQ/OQ kits	11069414
Repeating OQ C-850 en	

Maintenance kits

	Order no.
Kit Customer C-810	11062655
Frequently used wear and spare parts for self-servicing your device, conveniently gathered in one kit	
Kit Customer C-815	11062656
Frequently used wear and spare parts for self-servicing your device, conveniently gathered in one kit	
Kit Customer C-830	11062657
Frequently used wear and spare parts for self-servicing your device, conveniently gathered in one kit	
Kit Customer C-835	11062658
Frequently used wear and spare parts for self-servicing your device, conveniently gathered in one kit	
Kit Customer C-850	11062659
Frequently used wear and spare parts for self-servicing your device, conveniently gathered in one kit	

Алматы (7273)495-231
Ангарск (3955)60-70-56
Архангельск (8182)63-90-72
Астрахань (8512)99-46-04
Барнаул (3852)73-04-60
Белгород (4722)40-23-64
Благовещенск (4162)22-76-07
Брянск (4832)59-03-52
Владивосток (423)249-28-31
Владикавказ (8672)28-90-48
Владимир (4922)49-43-18
Волгоград (844)278-03-48
Вологда (8172)26-41-59
Воронеж (473)204-51-73
Екатеринбург (343)384-55-89

Иваново (4932)77-34-06
Ижевск (3412)26-03-58
Иркутск (395)279-98-46
Казань (843)206-01-48
Калининград (4012)72-03-81
Калуга (4842)92-23-67
Кемерово (3842)65-04-62
Киров (8332)68-02-04
Коломна (4966)23-41-49
Кострома (4942)77-07-48
Краснодар (861)203-40-90
Красноярск (391)204-63-61
Курск (4712)77-13-04
Курган (3522)50-90-47
Липецк (4742)52-20-81

Магнитогорск (3519)55-03-13
Москва (495)268-04-70
Мурманск (8152)59-64-93
Набережные Челны (8552)20-53-41
Нижний Новгород (831)429-08-12
Новокузнецк (3843)20-46-81
Новый Уренгой (3496)41-32-12
Новосибирск (383)227-86-73
Омск (3812)21-46-40
Орел (4862)44-53-42
Оренбург (3532)37-68-04
Пенза (8412)22-31-16
Петрозаводск (8142)55-98-37
Псков (8112)59-10-37
Пермь (342)205-81-47

Ростов-на-Дону (863)308-18-15
Рязань (4912)46-61-64
Самара (846)206-03-16
Санкт-Петербург (812)309-46-40
Саратов (845)249-38-78
Севастополь (8692)22-31-93
Саранск (8342)22-96-24
Симферополь (3652)67-13-56
Смоленск (4812)29-41-54
Сочи (862)225-72-31
Ставрополь (8652)20-65-13
Сургут (3462)77-98-35
Сыктывкар (8212)25-95-17
Тамбов (4752)50-40-97
Тверь (4822)63-31-35

Тольятти (8482)63-91-07
Томск (3822)98-41-53
Тула (4872)33-79-87
Тюмень (3452)66-21-18
Ульяновск (8422)24-23-59
Улан-Удэ (3012)59-97-51
Уфа (347)229-48-12
Хабаровск (4212)92-98-04
Чебоксары (8352)28-53-07
Челябинск (351)202-03-61
Череповец (8202)49-02-64
Чита (3022)38-34-83
Якутск (4112)23-90-97
Ярославль (4852)69-52-93

Россия +7(495)268-04-70

Казахстан +7(7172)727-132

Киргизия +996(312)96-26-47

<https://buchi.nt-rt.ru/> || bic@nt-rt.ru